

FIELD LOGGER



Operation Manual

Issue Date: 2014_03_03

Version Number: 1.03



John Whitehead Electrical Limited

Contents

- Panel Layout
- Display Messages
- Operating modes
 - Area
 - Speed
 - Distance
 - Time
 - Data Reset
- Setup Menu
 - Menu Layout
 - Implement Width
 - Implement Switch
 - Job Timers
 - Time Auto Resume
 - Area Units
 - Distance Units
 - Distance Setup
 - Automatic Distance Setup
 - Manual Distance Setup
- Special Menu
 - Test Mode – Wheel Freq
 - Test Mode – Imp Sw. State
- Connections
 - Plug
 - Wiring Diagram – Standard
 - Wiring Diagram – ISO plug
- Specifications



Panel Layout



Button Label	Short Press	Long Press
Reset	Nothing	Enters the Reset menu
Timers/Timing ⁽¹⁾	Toggles between Timer displays	Pauses the Field and Job timers
Distance/Plus	Toggles between Distance displays	Nothing
Speed/Minus	Changes to Speed display	Nothing
Area/Setup	Toggles between Area displays	Enters the Setup mode
Run/Pause ⁽²⁾	Starts and Pauses data recording	Starts and Pauses timers and data recording

- (1) Timers are only displayed when enabled in the setup menu
- (2) If an implement switch is in use the Run/Pause button will NOT restart data accumulation – in this case the implement switch has priority



Display Messages

Occasionally messages will be displayed on the bottom of the display to indicate the units current state

- **PAUSED**

PAUSED will be displayed when the data recording has been paused by pressing the Run/Pause button or the implement switch when the implement switch is in the 'on' position. PAUSED will then alternate with the displayed data, until the unit is brought out of pause mode by the pressing the Run/Pause button or the implement switch (if configured)

- **RESTARTED**

The unit will show this for about $\frac{1}{4}$ of a second after being brought out of pause mode

- **Timers Paused – Job Timers Enabled**

If the timers are running and either the Timing or Run/Pause buttons are held, then timers are paused and this message is displayed for about $\frac{1}{4}$ of a second

- **Timers Started – Job Timers Enabled**

Displayed when the timers are restarted. This could be by pressing and holding the Timing or Run/Pause buttons, or by the Timer Auto Resume feature that restarts the timer when the Implement switch is in its run position and motion is detected



Operating Modes

- Area

Pressing the Area button will alternate the display between Area and Total Area

The area covered is shown on the bottom line in either Hectares or Acres – this is can be changed in the setup menu

The area unit is shown using the following abbreviations:

Ha – Hectares ac – Acres

The area units can be changed in the setup menu

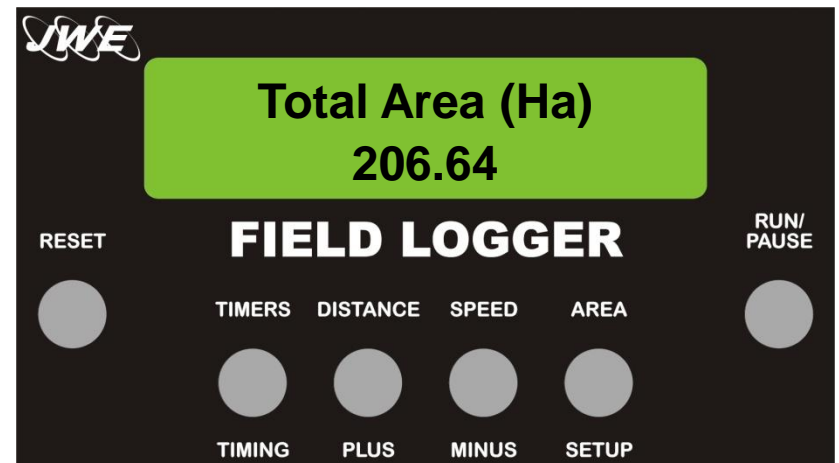
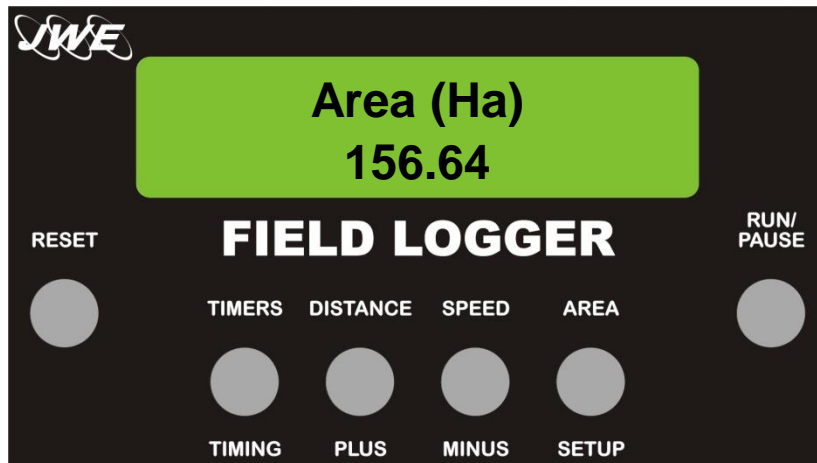

Operating Modes

- Speed

Pressing the Speed button will change the display to ground speed in kilometres per hour

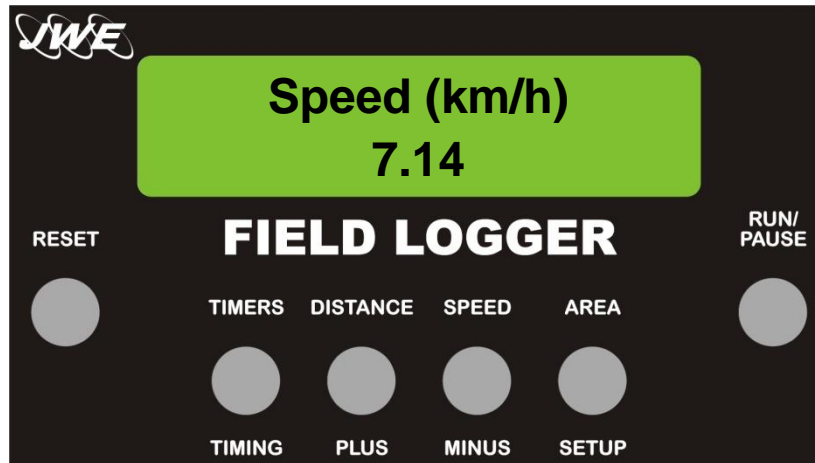

Operating Modes

- Distance

Pressing the Distance button will alternate the display between Distance and Total Distance

The accumulated distance for each is shown on the bottom line in either kilometres or metres – This can be changed in the setup menu

The distance unit is shown using the following abbreviations:

km – kilometres m – Metres

When displaying metres the number of decimal places increases to 3 giving a readout to 1mm resolution – however this is dependant on the speed sensor in use

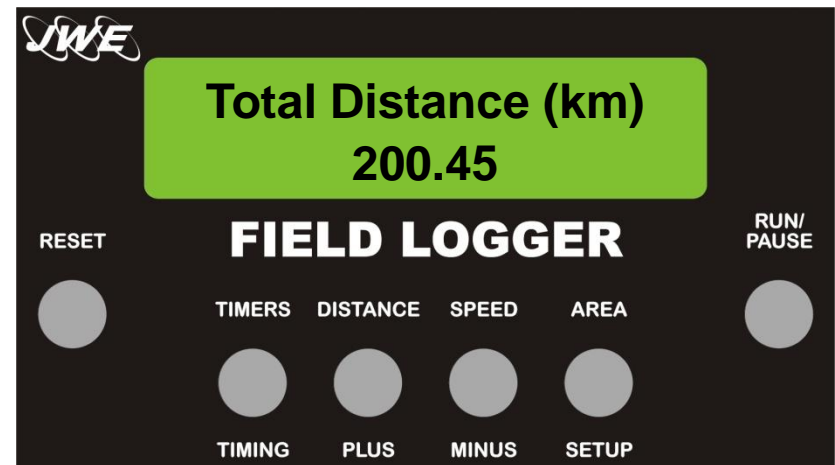
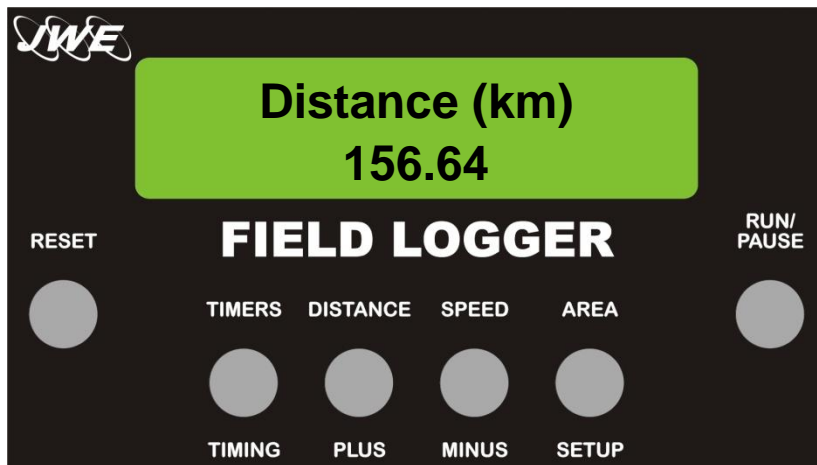

Operating Modes

- Job Timers – Optional Mode

The Job Timers are an optional function that can be enabled and disabled in the setup menu

The Timers have an automatic restart function that will automatically restart the timers if the implement is in its work position and there is movement – This is an option that is enabled in the setup menu

When the job timers are enabled the Timers button will alternate between Field Time and Job Time

To pause or restart the timers hold the Timing button (in any mode) until Timers Paused or Timers Started is shown on the display

If the timers are paused and being displayed their headings will show either Job Paused or Field Paused

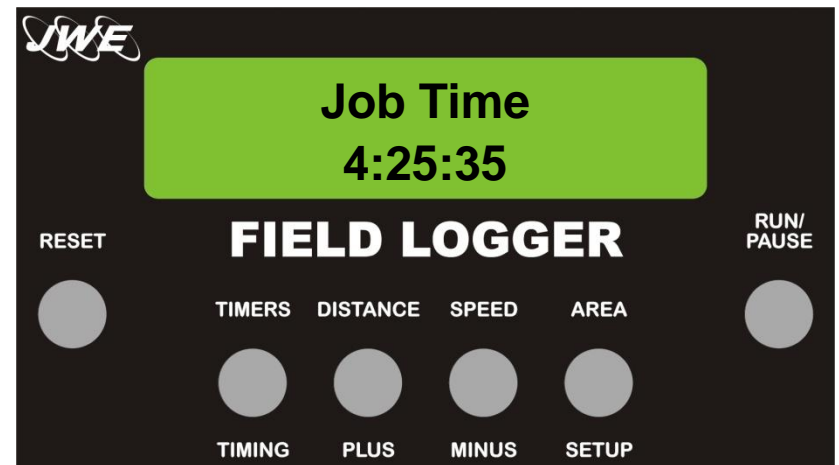
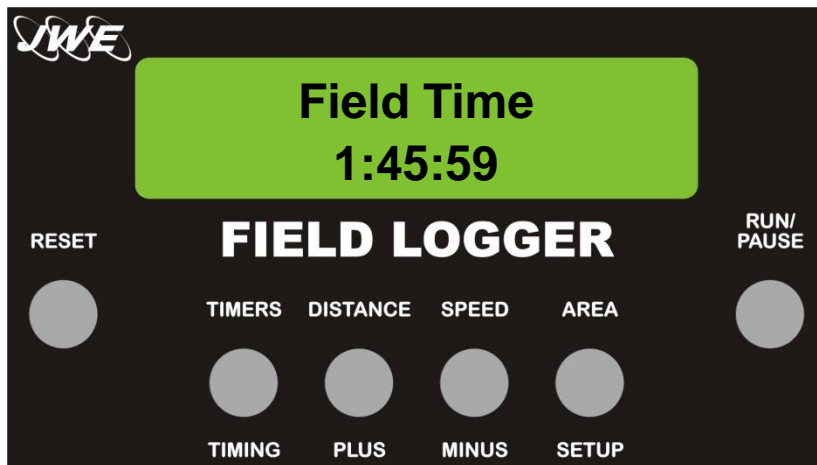

Operating Modes

- **Reset Data**

Holding the reset button displays the reset menu. The reset menu is divided into the 2 options below:

Reset Field – Zeros the area, distance and field timer

Reset Job – Zeros all the accumulated data

The selection is indicated by the > character at the beginning of the line

A short press on the Reset button changes the selection

Holding the Reset button selects the option indicated by the > character

The reset menu can be exited with out resetting any data by pressing any of the following buttons; Timers, Distance, Speed or Area

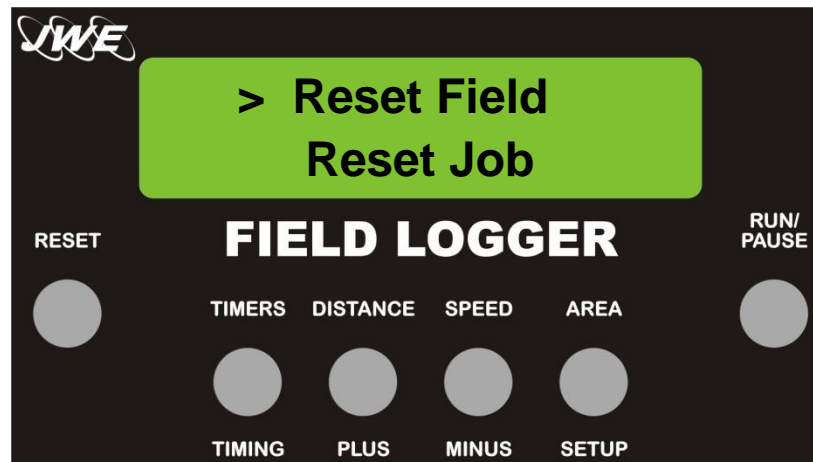

Setup Menu

- To enter the setup mode Hold the Setup button until the display shows Setup Mode (approximately 1 second) – This will remain on the display until the setup button is released
- Items are changed using the Plus and Minus buttons
- To move through the setup items press the setup button
- Holding reset for 1 second will return the setting to its default value
- Holding the setup button for 1 second will exit the setup menu and save any values that have been changed
- Setting changes are saved at the end of the setup menu when returning to the operating screen

NOTE: The Setup menu can only be cycled through in one direction

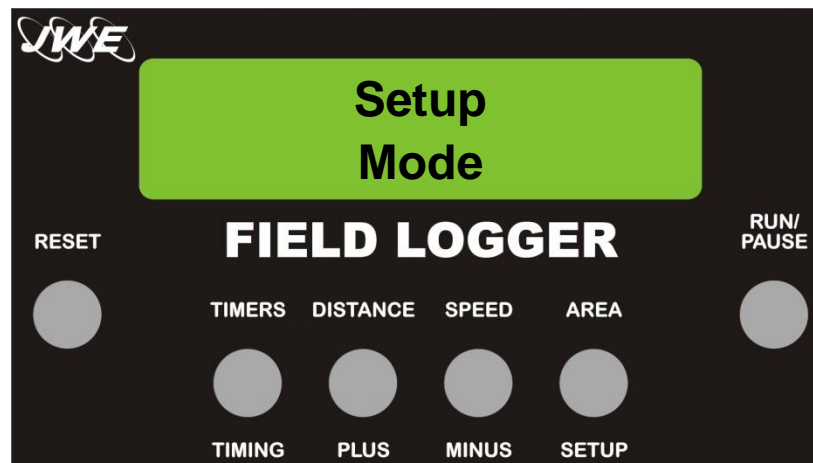

Setup Menu

- Menu Layout

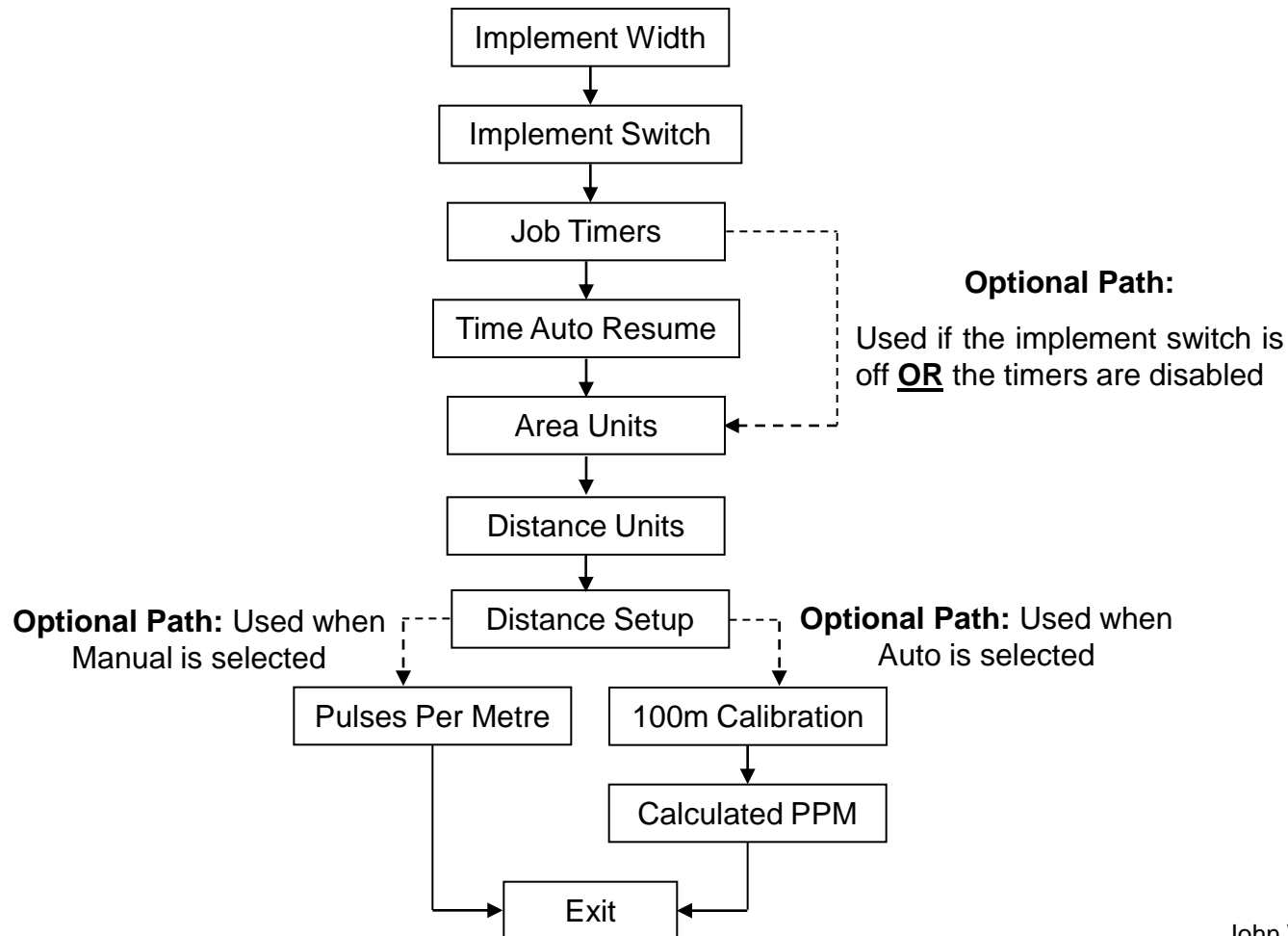

Setup Menu

- Implement Width

Use the Plus and Minus buttons enter the implements width in metres

Holding the Reset button for 1 second will set the width to the default value – 2.5 metres

The range of settings is from 0.8 – 26 metres in 0.01 meter (10 mm) increments

Press Setup to move to the next setup option

Hold Setup to exit the settings menu – any changes will be saved

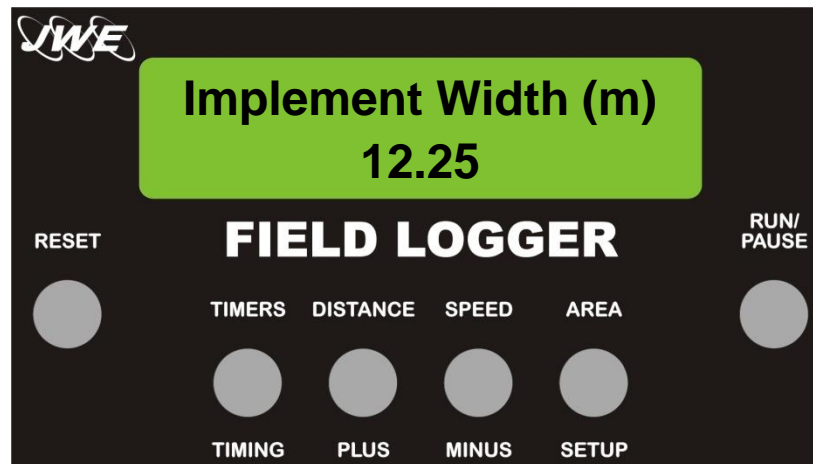

Setup Menu

- Implement Switch

Setup the use of an implement switch to pause distance and area recording

The settings are: OFF – Default mode no implement switch connected
Normal – Recording is paused when the switch is ON
Inverted – Recording is paused when the switch is OFF

Change the setting using the Plus or Minus button

Holding the Reset button for 1 second will set the width to the default value – OFF

Press Setup to move to the next setup option

Hold Setup to exit the settings menu – any changes will be saved

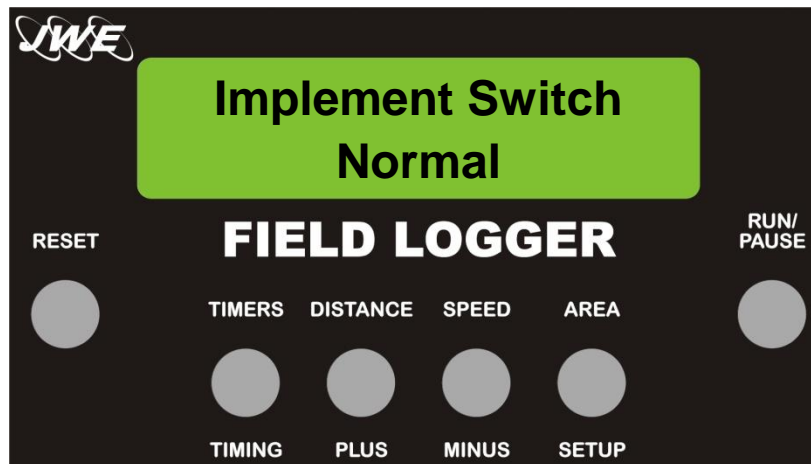

Setup Menu

- Job Timers

Enables and disables the job timers – When disabled the timers button has no effect

Use the Plus and Minus buttons to change the value

Holding the Reset button for 1 second will set the width to the default value – Enabled

Press Setup to move to the next setup option

Hold Setup to exit the settings menu – any changes will be saved

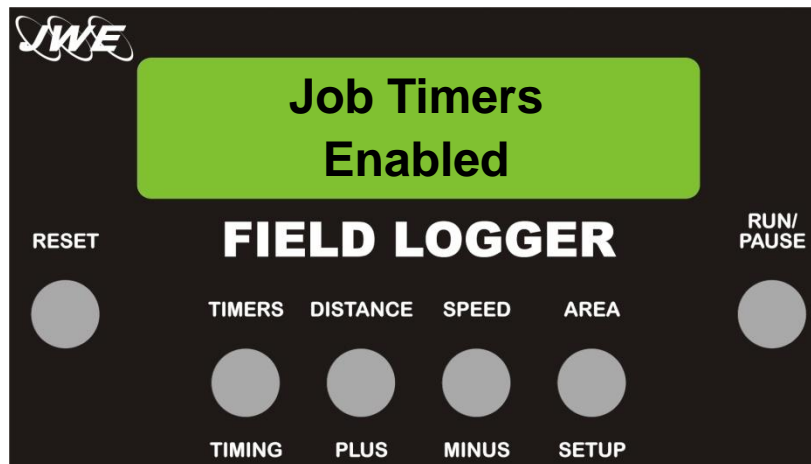

Setup Menu

- Time Auto Resume – Optional Setting

This option is only available if the job timers are enabled and an implement switch is being used.

This function automatically restarts the job timers when the implement is in it's working position and motion

Use the Plus and Minus buttons to adjust

Holding the Reset button for 1 second will set the width to the default value – Enabled

Press Setup to move to the next setup option

Hold Setup to exit the settings menu – any changes will be saved

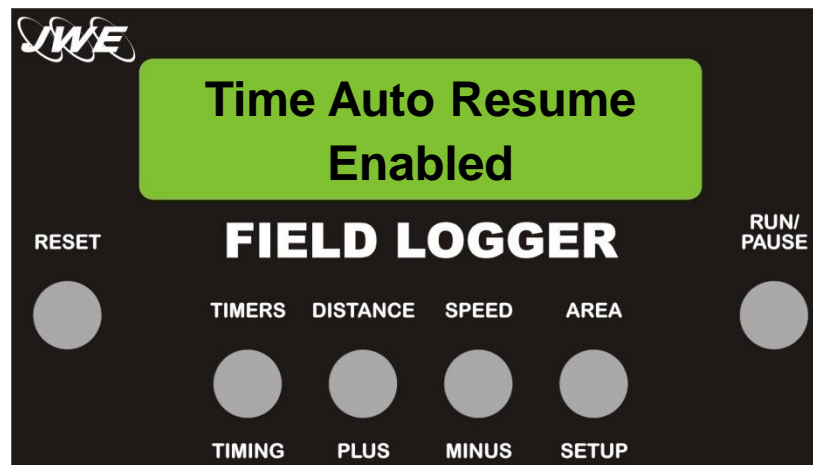

Setup Menu

- Area Units

This setting sets the units for displaying area

Using the Plus and Minus select either Hectares or Acres

Holding Reset for 1 second will change the display to the default setting – Hectares

Press Setup to move to the next setup option

Hold Setup to exit the settings menu – any changes will be saved

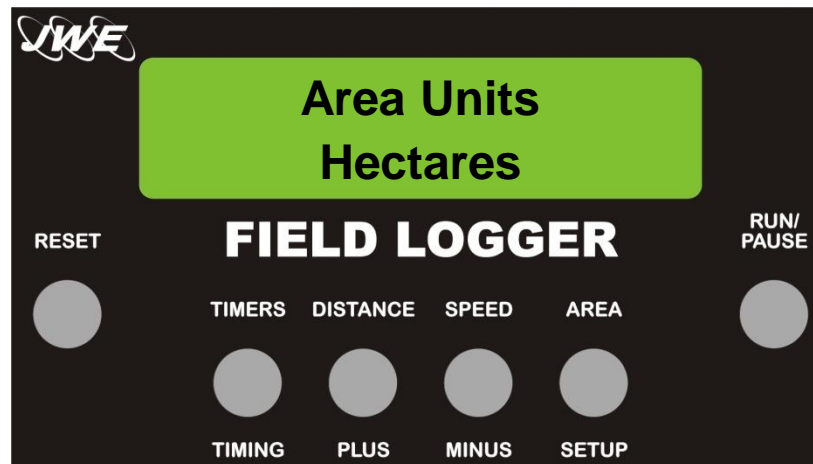

Setup Menu

- Distance Units

This setting sets the units for displaying distance covered

Using the Plus and Minus select either Kilometres or Metres

Holding Reset for 1 second will change the display to the default setting – Kilometres

Press Setup to move to the next setup option

Hold Setup to exit the settings menu – any changes will be saved

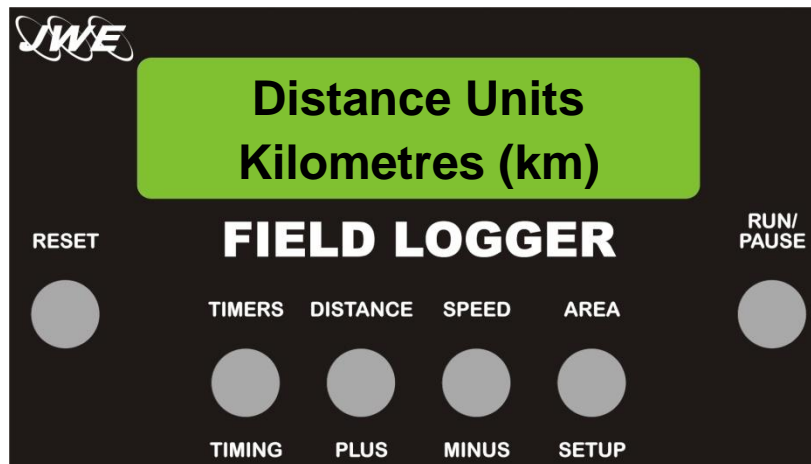

Setup Menu

- Distance Setup

There are 2 ways to enter the wheel sensors calibration factor

Automatically (Auto): The unit counts the number of pulses the wheel sensor generates over 100 metres, then calculates the number of pulses per metre

Manually: If the pulses per metre for the sensor are known this option allows the value to be entered using the Plus and Minus buttons

Use the Plus and Minus buttons to select the desired option then press Setup to move to the next stage of wheel sensor calibration

Holding the Setup button will exit the settings menu – any changes will be saved

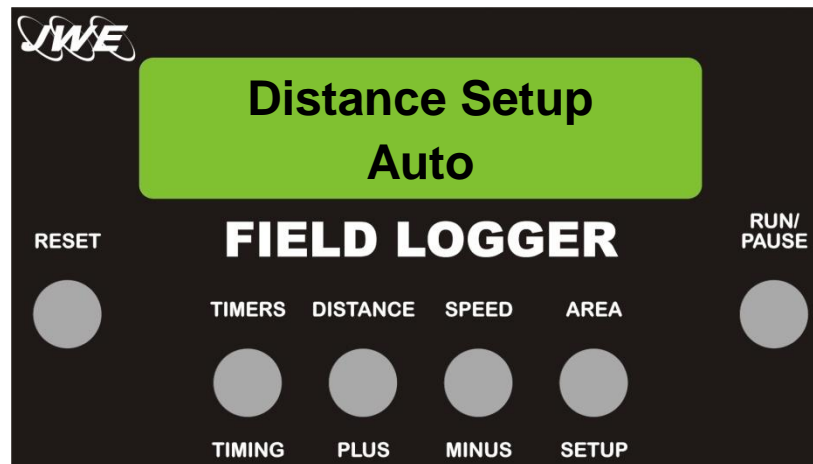

Setup Menu

• Automatic Distance Setup

1) Drive to the start of your marked 100metres

1a) Pressing Reset at this point will skip the calibration process and leave the distance setting unchanged, the unit will show Auto Cal Aborted then return to operating mode and save any changes made to the settings

2) Press Setup to start the calibration

3) Drive the measured distance – while motion is detected the pulse count (left) and sensor frequency (right) are shown on the display

NOTE: When no motion is detected the display alternates between the count and frequency and Stop = Setup

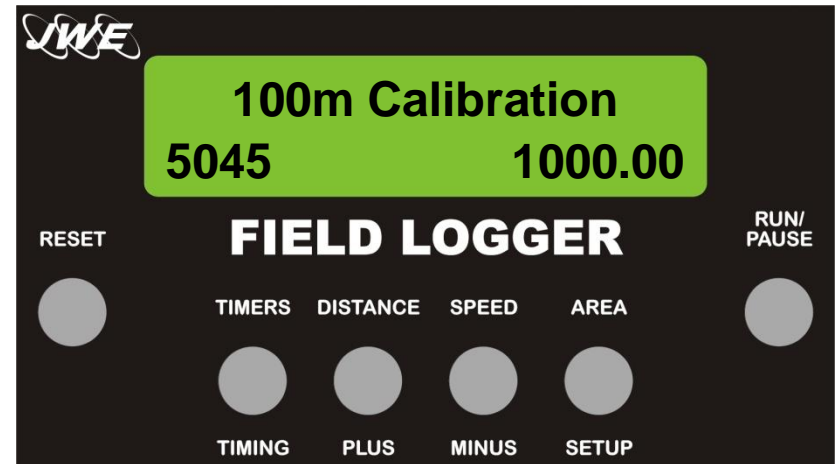
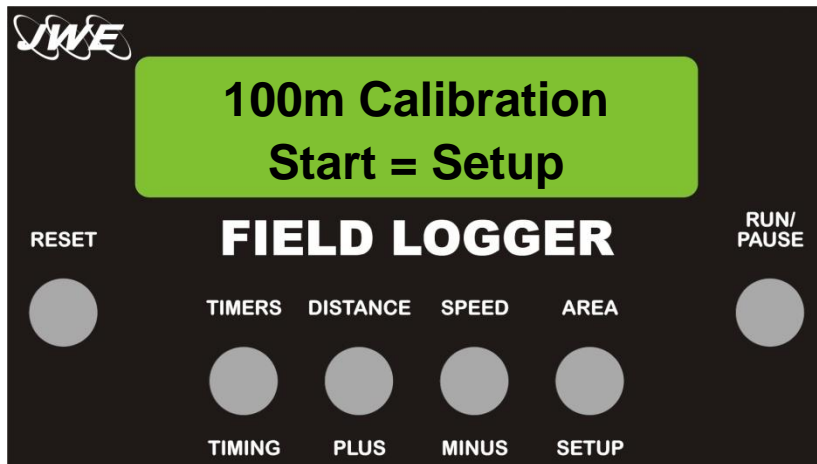

Setup Menu

- Automatic Distance Setup

4) At the end of the 100 metres stop and press Setup.

If the calculated pulse rate is below the minimum value of 0.1 pulses per meter the Field Logger will show “PULSE RATE TOO LOW” then ask to use the default pulse per meter value

NOTE: If the accumulated number of pulses goes above the limit of 25000 Pulses per meter the Field Logger will stop accumulating pulses and show “PULSE RATE TOO HIGH” then ask to use the default pulse per meter value

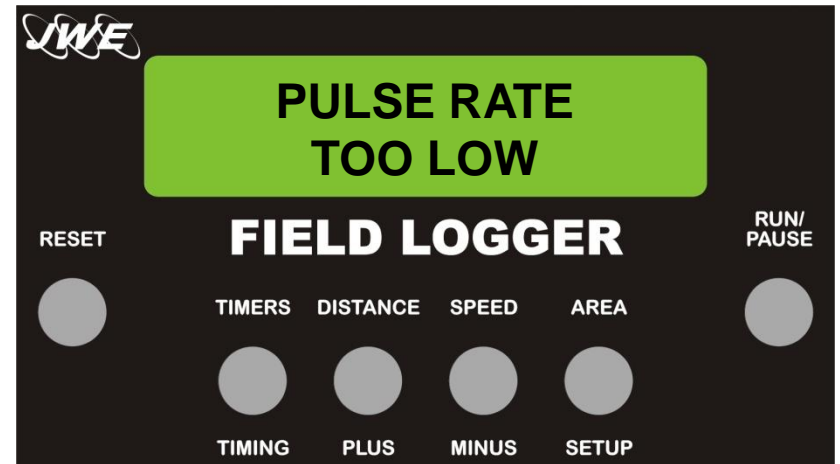
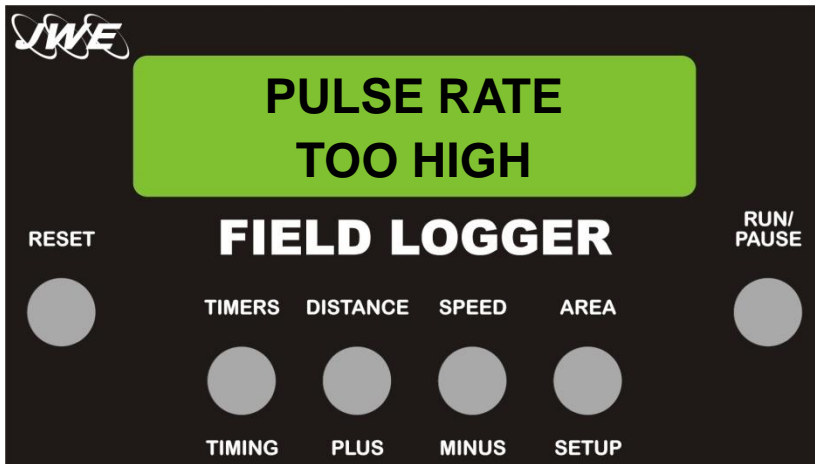

Setup Menu

• Automatic Distance Setup

5) The display shows Calculated PPM and the bottom line will alternate between the calculated value, Accept = Setup and Discard = Minus

NOTE: If the calculated value is outside the range of 0.1 PPM - 25000 PPM the Field Logger will display an error then the heading will be "Use Default PPM" and the pulse per meter value is shown as the default value of 1

6a) Press Setup to confirm the value is correct and exit the setup menu – the new PPM value is stored along with any other settings that have changed

6b) Press Minus to discard the PPM value – The unit will show Value Discarded and leave the value unchanged save any values that have been changed and exit the setup menu

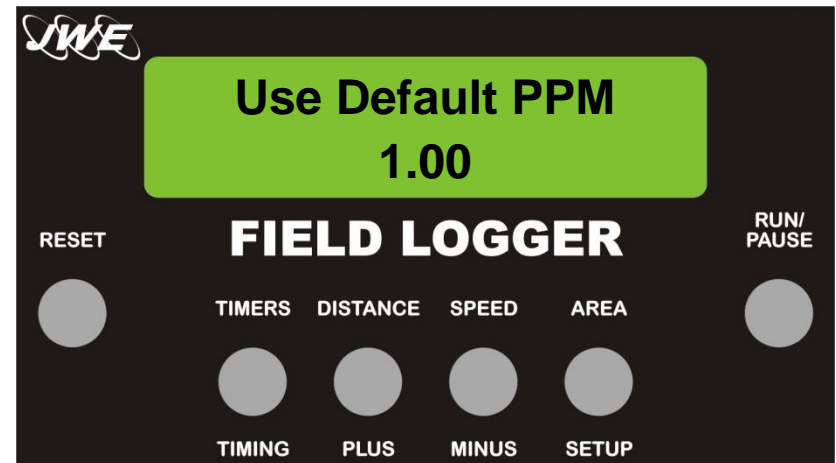
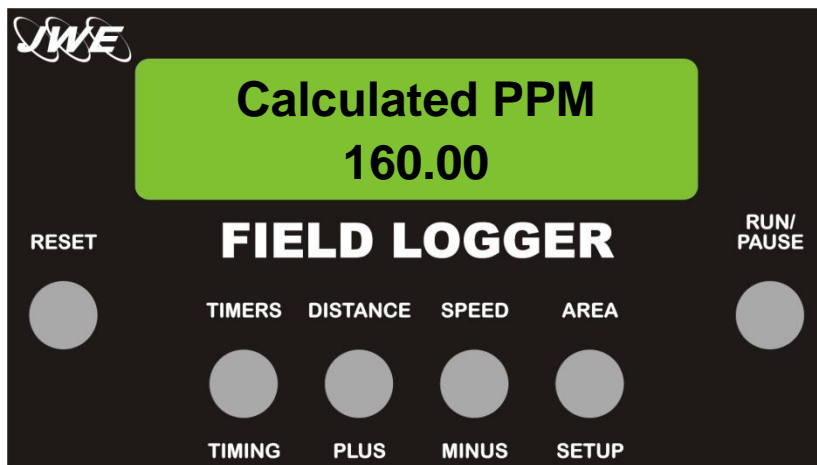

Setup Menu

- Manual Distance Setup

Using the Plus and Minus buttons set the number of pulses per meter for your speed sensor

Holding the Reset button for 1 second will set the width to the default value – 1.00 PPM

Press the Setup button to exit the settings menu and save the settings

Hold Setup to exit the settings menu – any changes will be saved

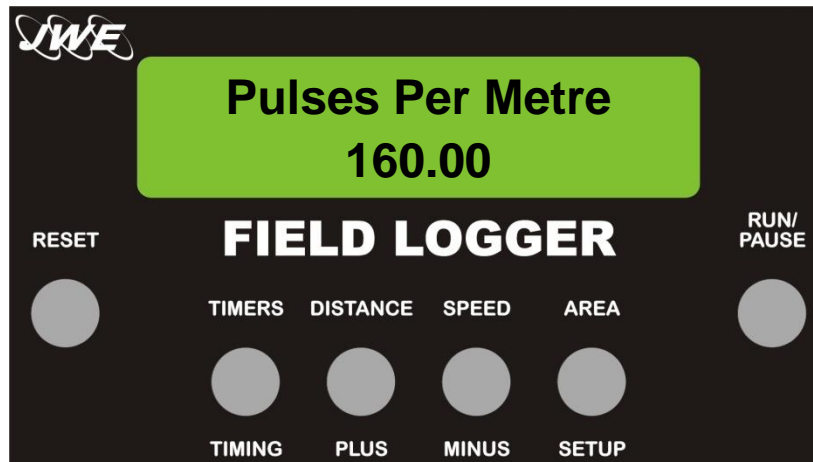

Special Menu

- Test Mode

Test Mode allows the monitoring of the units function to aid in troubleshooting

To enter Test mode

- 1) Switch unit off
- 2) Hold Speed and Area and turn the power on
- 3) Once the display shows Test Mode release the buttons

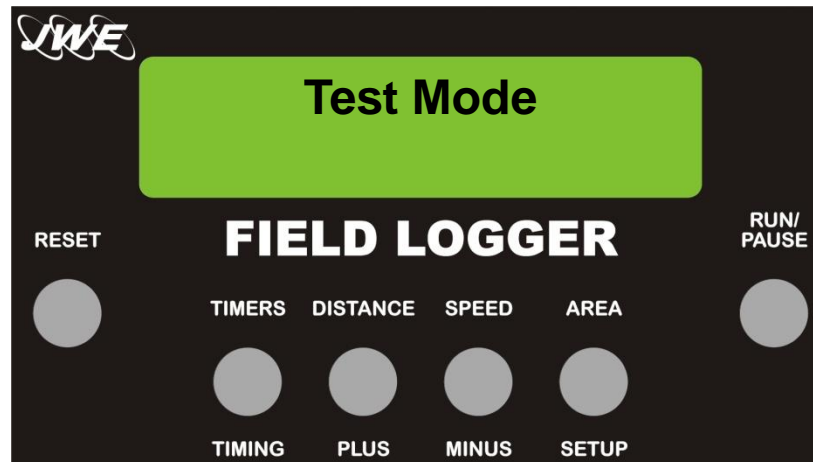

Special Menu

- Test Mode – Wheel Freq (Hz)

The first item in the menu is the wheel sensor frequency – this is the raw frequency generated by the wheel sensor

To check the operation of the wheel sensor drive a short distance. The display will show a frequency proportional to your ground speed – If this does not happen check the sensor and its connection

Press Setup to check the implement switch.

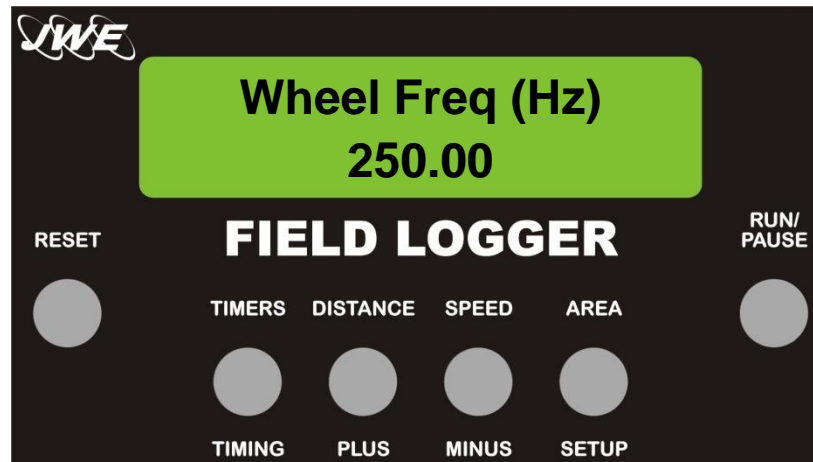

Special Menu

- Test Mode – Imp Sw State (Implement Switch State)

If the switch is not programmed Disabled is shown - enable in the setup menu

Toggle the switch the position of the switch is shown as follows:

OFF – The implement is in its work position

ON – The implement is in its hold position

If the display is opposite to what is expected swap the implement switch setting in the setup menu

If the display does not change check the switch and its connection

Exit test mode by pressing Setup

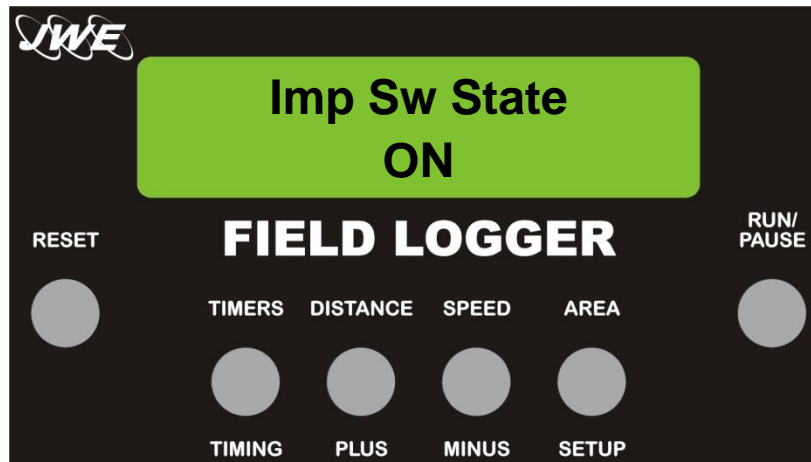

Connections

- Field Logger Case Plug



Looking into the plug on the field logger

Pin	Function
1	Battery Positive
2	Battery Negative
3	Speed Sensor
4	Implement Switch
5	Not Connected
6	Sensor Positive
7	Sensor Negative



Connections

- Standard Wiring

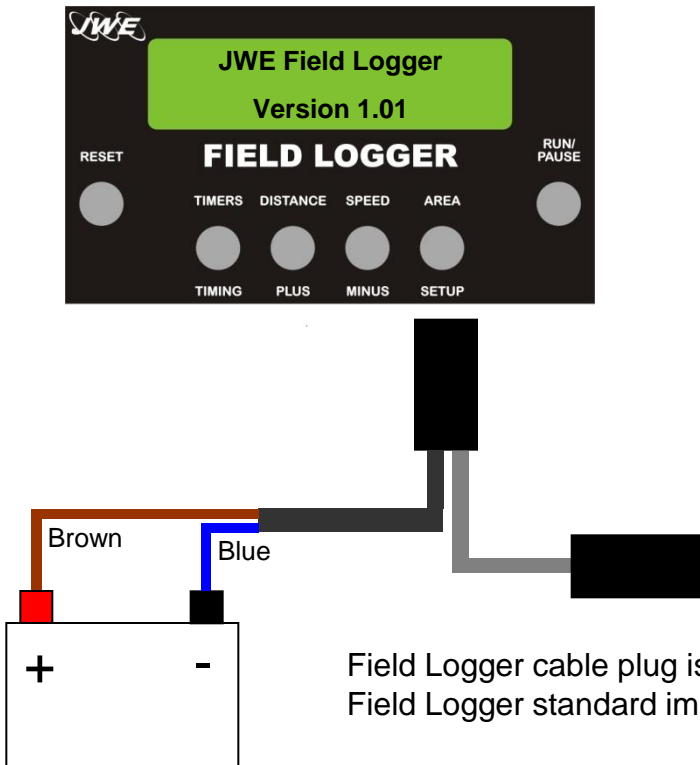

Field Logger Plug Pin	Wire ID	Implement Plug Pin	Field Logger Connection
1	Brown	Not Connected	Battery Positive
2	Blue	Not Connected	Battery Negative
3	3	3	Speed Sensor
4	4	4	Implement Switch
5	Not Connected		
6	1	1	Sensor Positive
7	2	2	Sensor Negative

Field Logger cable plug is JWE Part Number: C016 30D006 110 12
 Field Logger standard implement plug is JWE Part Number: C016 20D003 110 12



Connections

- ISO Plug Wiring



Wire ID	Field Logger Pin	ISO Plug Pin	ISO Bus Connection
1	1	6	Battery Positive
2	2	7	Battery Negative
3	3	1	Radar Output
3	3	2	Crown Wheel Output (Optional)
4	4	4	Lift Position - Implement Switch
-	5		Not Used
-	6	3	Not Used
-	7	5	Not Used

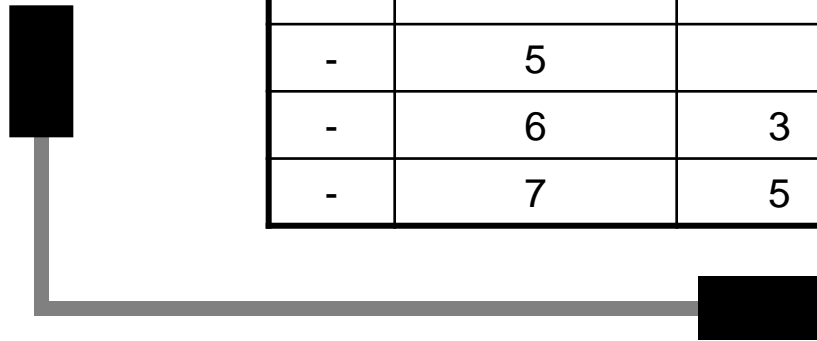

Field Logger cable plug is JWE Part Number: C016 30D006 110 12
 ISO plug on the cable is JWE Part Number: C016 30H006 110 12

Specifications

- Maximum Input voltage – 40 Volts
- Wheel Speed frequency range⁽¹⁾ – 2.0 Hz – 2 kHz
- Area and distance maximum frequency – 2 kHz
- Supported sensors – 12 volt output compatible
 - Wheel
 - Closing contact - reed switch
 - NPN Sensor
 - Implement Switch
 - Closing contact – micro-switch, reed switch
 - NPN Sensor

Specifications are subject to change without notice

- (1) The upper frequency is the point where the error is greater than 1%; above this speed read out may not be accurate

